

INSTYTUT TECHNIKI BUDOWLANEJ
PL 00-611 WARSZAWA
ul. Filtrowa 1
tel.: (+48 22) 825-04-71
(+48 22) 825-76-55
fax: (+48 22) 825-52-86
www.itb.pl



Member of



www.eota.eu

European Technical Assessment

**ETA-21/0243
of 11/03/2021**

General Part

Technical Assessment Body issuing the European Technical Assessment

Instytut Techniki Budowlanej

Trade name of the construction product

RAWL R-KEM II / RAWL R-KEM II-S / RAWL R-KEM II-W and RAWL RM50 / RAWL RM50-S / RAWL RM50-W

Product family to which the construction product belongs

Bonded fasteners of sizes M8 to M30 for use in uncracked concrete

Manufacturer

RAWLPLUG S.A.
ul. Kwidzyńska 6
51-416 Wrocław
Poland

Manufacturing plant

Manufacturing Plant no. 3

This European Technical Assessment contains

18 pages including 3 Annexes which form an integral part of this Assessment

This European Technical Assessment is issued in accordance with regulation (EU) No 305/2011, on the basis of

European Assessment Document EAD 330499-01-0601 "Bonded fasteners for use in concrete"

This European Technical Assessment is issued by the Technical Assessment Body in its official language. Translations of this European Technical Assessment in other languages shall fully correspond to the original issued document and should be identified as such.

Communication of this European Technical Assessment, including transmission by electronic means, shall be in full. However, partial reproduction may be made, with the written consent of the issuing Technical Assessment Body. Any partial reproduction has to be identified as such.

Specific Part

1 Technical description of the product

The RAWL R-KEM II / RAWL R-KEM II-S / RAWL R-KEM II-W and RAWL RM50 / RAWL RM50-S / RAWL RM50-W are bonded anchors (injection type) consisting of an injection mortar cartridge using an applicator gun equipped with a special mixing nozzle and threaded anchor rod sizes M8 to M30 made of:

- galvanized carbon steel,
 - stainless steel,
 - high corrosion resistant stainless steel,
- with hexagon nut and washer.

The threaded rod is placed into a drilled hole previously cleaned and injected (using an applicator gun) with a mortar with a slow and slight twisting motion. The rod is anchored by the bond between rod, mortar and concrete.

The product description is given in Annex A.

2 Specification of the intended use in accordance with the applicable European Assessment Document (EAD)

The performances given in Section 3 are only valid if the anchorages are used in compliance with the specifications and conditions given in Annex B.

The performances given in this European Technical Assessment are based on an assumed working life of the anchor of 50 and/or 100 years. The indications given on the working life cannot be interpreted as a guarantee given by the producer or the Technical Assessment Body, but are to be regarded only as a means for choosing the right products in relation to the expected economically reasonable working life of the works.

3 Performance of the product and references to the methods used for its assessment

3.1 Performance of the product

3.1.1 Mechanical resistance and stability (BWR 1)

Essential characteristic	Performance
Characteristic resistance to static and quasi static loading, displacements	See Annex C1 to C4

3.1.2 Hygiene, health and the environment (BWR 3)

No performance assessed.

3.2 Methods used for the assessment

The assessment of the products has been made in accordance with the European Assessment Document EAD 330499-01-0601 "Bonded fasteners for use in concrete".

4 Assessment and verification of constancy of performance (AVCP) system applied, with reference to its legal base

According to Decision 96/582/EC of the European Commission the system 1 of assessment and verification of constancy of performance applies (see Annex V to regulation (EU) No 305/2011).

5 Technical details necessary for the implementation of the AVCP system, as provided for in the applicable European Assessment Document (EAD)

Technical details necessary for the implementation of the AVCP system are laid down in the control plan deposited at Instytut Techniki Budowlanej.

For type testing the results of the tests performed as part of the assessment for the European Technical Assessment shall be used unless there are changes in the production line or plant. In such cases the necessary type testing has to be agreed between Instytut Techniki Budowlanej and the notified body.

Issued in Warsaw on 11/03/2021 by Instytut Techniki Budowlanej



Anna Panek, MSc
Deputy Director of ITB

Threaded anchor rods

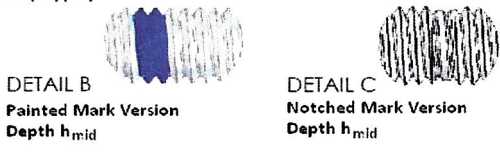
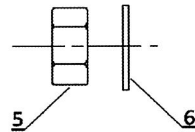
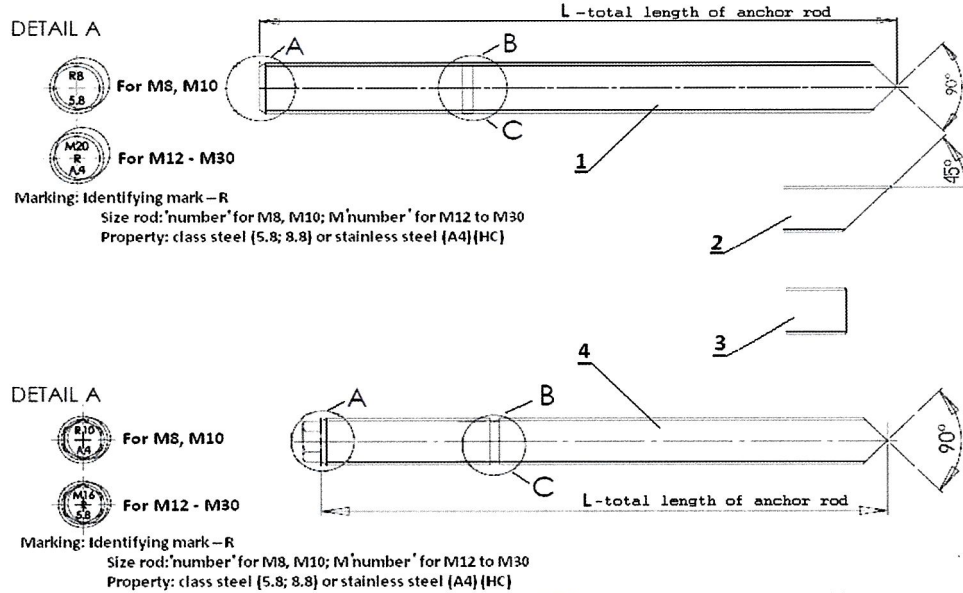

1. Anchor rod R-STUDS-{88},{A4},{HC}-FL
2. 45° shape with anchor rod
3. The flat end of anchor rod
4. Anchor rod R-STUDS-{88},{A4},{HC} with the hexagonal tip
5. Hexagonal nut
6. Washer

**RAWL R-KEM II / RAWL R-KEM II-S / RAWL R-KEM II-W
and RAWL RM50 / RAWL RM50-S / RAWL RM50-W**

Product description
Threaded anchor rods

Annex A1
of European
Technical Assessment
ETA-21/0243

Table A1: Threaded rods

Part	Designation		
	Steel, zinc plated	Stainless steel	High corrosion resistance stainless steel
Threaded rod	Steel, property class 5.8 to 12.9, acc. to EN ISO 898-1; zinc plated $\geq 5 \mu\text{m}$ acc. to EN ISO 4042 or hot-dip galvanized $\geq 45 \mu\text{m}$ acc. to EN ISO 10684	Material 1.4401, 1.4404, 1.4571 acc. to EN 10088; property class 70 and 80 (A4-70 and A4-80) acc. to EN ISO 3506 Corrosion resistance class CRC III acc. to EN 1993-1-4:2006+A1:2015	Material 1.4529, 1.4565, 1.4547 acc. to EN 10088; property class 70 acc. to EN ISO 3506 Corrosion resistance class CRC V acc. to EN 1993-1-4:2006+A1:2015
Hexagon nut	Steel, property class 5 to 12, acc. to EN 898-2; zinc plated $\geq 5 \mu\text{m}$ acc. to EN ISO 4042 or hot-dip galvanized $\geq 45 \mu\text{m}$ acc. to EN ISO 10684	Material 1.4401, 1.4404, 1.4571 acc. to EN 10088; property class 70 and 80 (A4-70 and A4-80) acc. to EN ISO 3506 Corrosion resistance class CRC III acc. to EN 1993-1-4:2006+A1:2015	Material 1.4529, 1.4565, 1.4547 acc. to EN 10088; property class 70 acc. to EN ISO 3506 Corrosion resistance class CRC V acc. to EN 1993-1-4:2006+A1:2015
Washer	Steel, acc. to EN ISO 7089; zinc plated $\geq 5 \mu\text{m}$ acc. to EN ISO 4042 or hot-dip galvanized $\geq 45 \mu\text{m}$ acc. to EN ISO 10684	Material 1.4401, 1.4404, 1.4571 acc. to EN 10088; corresponding to anchor rod material Corrosion resistance class CRC III acc. to EN 1993-1-4:2006+A1:2015	Material 1.4529, 1.4565, 1.4547 acc. to EN 10088; corresponding to anchor rod material Corrosion resistance class CRC V acc. to EN 1993-1-4:2006+A1:2015

Commercial threaded rods (in the case of rods made of galvanized steel – rods with property class ≤ 8.8 only), with:

- material and mechanical properties according to Table A1,
- confirmation of material and mechanical properties by inspection certificate 3.1 according to EN-10204:2004; the documents shall be stored,
- marking of the threaded rod with the embedment depth.

Note: Commercial standard threaded rods made of galvanized steel with property class above 8.8 are not permitted in some Member States.

Table A2: Injection mortars

Product	Composition
RAWL R-KEM II / RAWL R-KEM II-S / RAWL R-KEM II-W RAWL RM50 / RAWL RM50-S / RAWL RM50-W	Bonding agent: polyester resin styrene free Hardener: dibenzoyl peroxide Additive: quartz sand Supplied in three colours: standard, grey (G) and stone (ST)

**RAWL R-KEM II / RAWL R-KEM II-S / RAWL R-KEM II-W
and RAWL RM50 / RAWL RM50-S / RAWL RM50-W**

Product description
Materials

Annex A2
of European
Technical Assessment
ETA-21/0243

Coaxial cartridge –

150 ml, 280 ml, 300 ml, 310 ml, 330 ml, 380 ml, 400 ml, 410 ml, 420 ml.

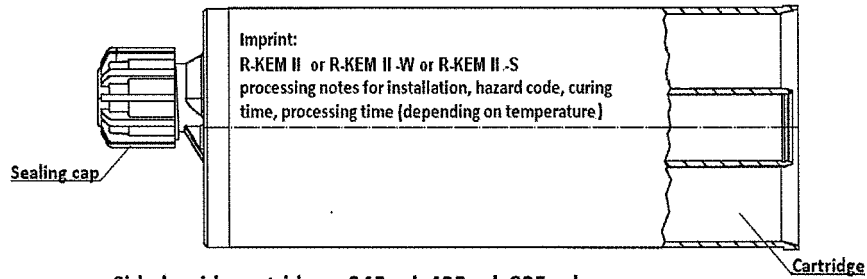

Side by side cartridge – 345 ml, 425 ml, 825 ml.

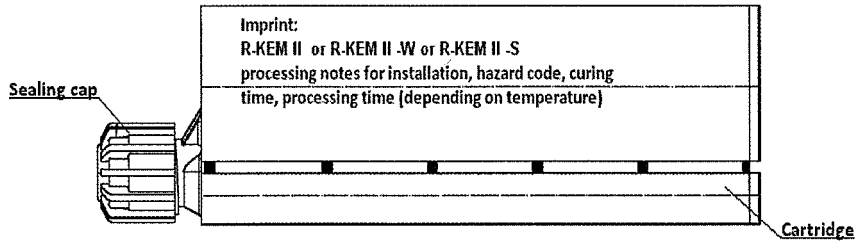

Cartridge a single component for two part foil capsules –

150 ml, 175 ml, 280ml, 300 ml, 310 ml, 380 ml, 400 ml, 550 ml, 600 ml.

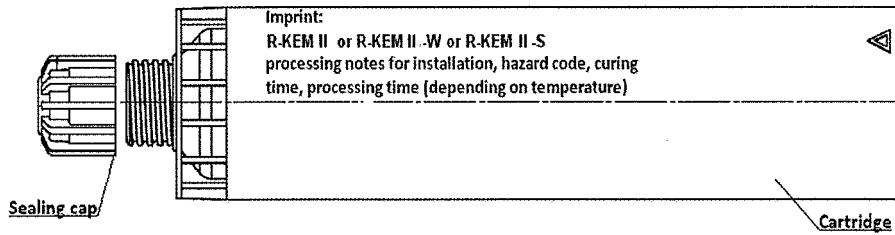

Mixer for cartridge

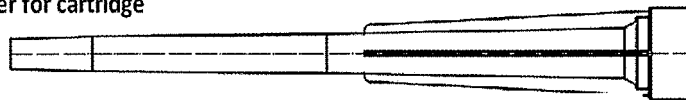

**RAWL R-KEM II / RAWL R-KEM II-S / RAWL R-KEM II-W
and RAWL RM50 / RAWL RM50-S / RAWL RM50-W**

Product description
Cartridge types and sizes (1)

Annex A3
of European
Technical Assessment
ETA-21/0243

Foil capsule (CFS system) –

150 ml, 175 ml, 280ml, 300 ml, 310 ml, 380 ml, 400 ml, 550 ml, 600 ml.

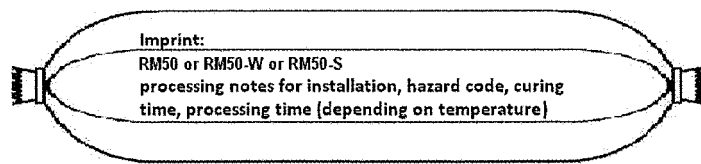

Mixer for foil capsule (CFS system)

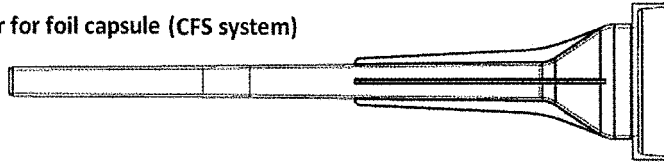

Mixer standard plus adapter CFS+ for foil capsule

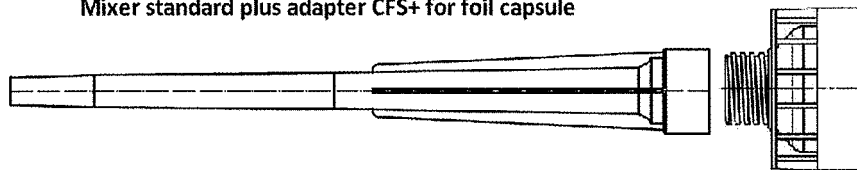

Gun for foil capsule (CFS system)

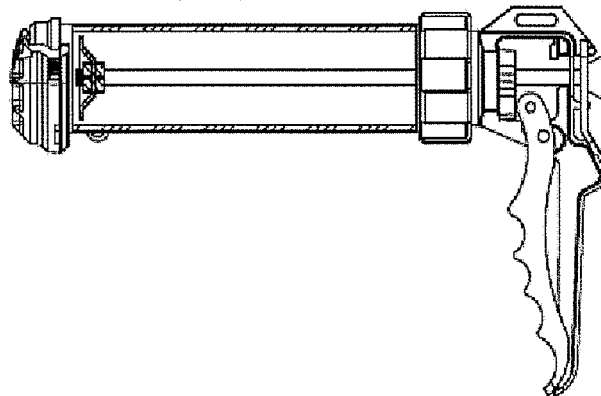

Gun for capsule (RAWL CFS +)

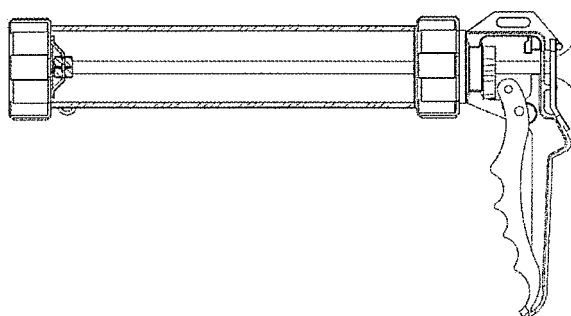

**RAWL R-KEM II / RAWL R-KEM II-S / RAWL R-KEM II-W
and RAWL RM50 / RAWL RM50-S / RAWL RM50-W**

Product description
Cartridge types and sizes (2)

Annex A4
of European
Technical Assessment
ETA-21/0243

<p>Specification of intended use</p> <p>Anchors subject to: Static and quasi-static loads: sizes M8 to M30.</p> <p>Base material:</p> <ul style="list-style-type: none"> ▪ Reinforced or unreinforced normal weight concrete of strength class C20/25 to C50/60 to EN 206:2013+A1:2016. ▪ Uncracked concrete. <p>Temperature ranges:</p> <p>Installation temperature (temperature of substrate):</p> <ul style="list-style-type: none"> ▪ -5°C to +30°C in case of R-KEM II / RM50 (standard version). ▪ -5°C to +40°C in case of R-KEM II-S / RM50-S (version for summer season). ▪ -20°C to +20°C in case of R-KEM II-W / RM50-W (version for winter season). <p>In-service temperature: The anchorages may be used in the following temperature range:</p> <ul style="list-style-type: none"> ▪ -40°C to +40°C (max. short term temperature +40°C and max. long term temperature +24°C). ▪ -40°C to +80°C (max. short term temperature +80°C and max. long term temperature +50°C). <p>Use conditions (environmental conditions):</p> <ul style="list-style-type: none"> ▪ Structures subject to dry internal conditions: all materials. ▪ For all other conditions according to EN 1993-1-4 corresponding to corrosion resistance class (CRC): elements made of stainless steel or high corrosion resistance steel (HCR). <p>Design:</p> <ul style="list-style-type: none"> ▪ Anchorages under static or quasi-static loads are designed in accordance to EN 1992-4:2018 and EOTA Technical Report TR 055. ▪ Anchorages are designed under the responsibility of the engineer experienced in anchorages and concrete work. ▪ Verifiable calculation notes and drawings are prepared taking account of the loads to be anchored. The position of the anchor is indicated on the design drawings (e.g. position of the anchor relative to reinforcement or to supports, etc.). <p>Installation:</p> <ul style="list-style-type: none"> ▪ Dry or wet concrete (use category I1). ▪ Flooded holes (use category I2). ▪ Installation direction D2 (downward and horizontal installation). ▪ The anchorages are suitable for rotary hammer drilled holes. 	
<p>RAWL R-KEM II / RAWL R-KEM II-S / RAWL R-KEM II-W and RAWL RM50 / RAWL RM50-S / RAWL RM50-W</p>	<p>Annex B1 of European Technical Assessment ETA-21/0243</p>
<p>Intended use Specification</p>	

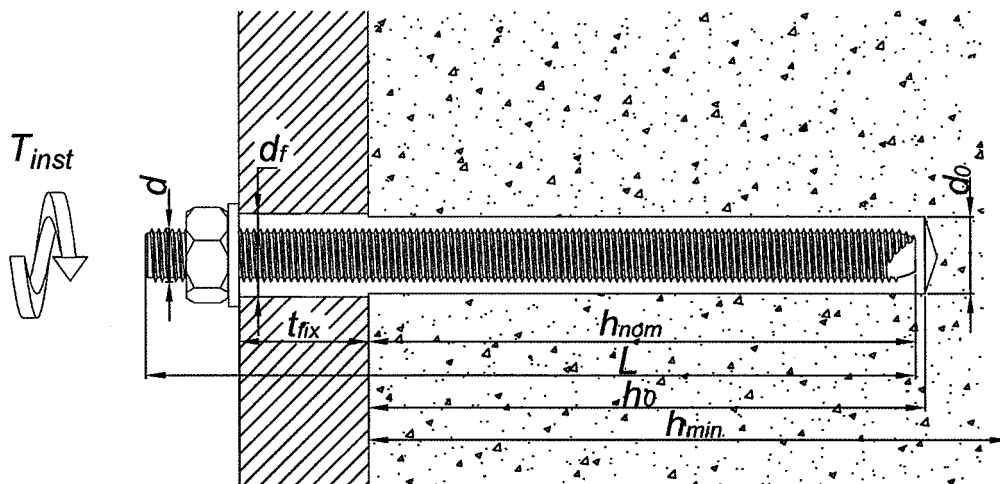

Table B1: Installation parameters

Size			M8	M10	M12	M16	M20	M24	M30
Diameter of anchor rod	d	[mm]	8	10	12	16	20	24	30
Nominal drilling diameter	d ₀	[mm]	10	12	14	18	24	28	35
Maximum diameter hole in the fixture	d _f	[mm]	9	12	14	18	22	26	33
Effective embedment depth	h _{ef,min}	[mm]	60	70	80	100	120	140	165
	h _{ef,max}	[mm]	160	200	240	320	400	400	600
Depth of the drilling hole	h ₀	[mm]	h _{ef} + 5 mm						
Minimum thickness of the concrete slab	h _{min}	[mm]	h _{ef} + 30 mm; ≥ 100 mm			h _{ef} + 2d ₀			
Maximum installation torque	T _{inst,max}	[Nm]	10	20	40	80	120	180	300
Minimum spacing	s _{min}	[mm]	40	40	40	50	60	70	85
Minimum edge distance	c _{min}	[mm]	40	40	40	50	60	70	85

**RAWL R-KEM II / RAWL R-KEM II-S / RAWL R-KEM II-W
and RAWL RM50 / RAWL RM50-S / RAWL RM50-W**

Intended use
Installation parameters

Annex B2
of European
Technical Assessment
ETA-21/0243

Table B2: Maximum processing time and minimum curing time

Mortar temperature [°C]	Concrete (substrate) temperature [°C]	Maximum processing time [min.]			Minimum curing time ¹⁾ [min.]		
		R-KEM II / RM50	R-KEM II-S / RM50-S	R-KEM II-W / RM50-W	R-KEM II / RM50	R-KEM II-S / RM50-S	R-KEM II-W / RM50-W
+5	-20	-	-	45	-	-	1440
+5	-15	-	-	30	-	-	1080
+5	-10	-	-	20	-	-	480
+5	-5	70	180	11	480	1440	300
+5	0	45	120	7	240	1080	120
+5	+5	25	60	5	120	720	60
+10	+10	15	45	2	90	480	45
+15	+15	9	25	1,5	60	360	30
+20	+20	5	15	1	45	240	15
+25	+30	2	7	-	30	90	-
+25	+35	-	6	-	-	60	-
+25	+40	-	5	-	-	45	-

¹⁾ Minimum resin temperature for installation +5°C; maximum resin temperature for installation +25°C. For wet condition and flooded holes the curing time must be doubled.

**RAWL R-KEM II / RAWL R-KEM II-S / RAWL R-KEM II-W
and RAWL RM50 / RAWL RM50-S / RAWL RM50-W**

Intended use
Maximum processing time and minimum curing time

Annex B3
of European
Technical Assessment
ETA-21/0243

Additional mixer extension



*Variable length from 300 mm up 1000 mm

Manual blower pump

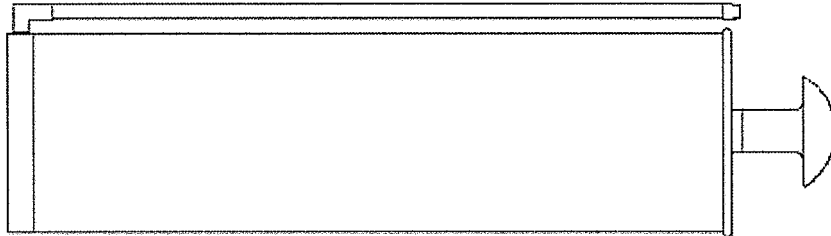

Steel brush



Table B3: Brush diameter

Size rod			M8	M10	M12	M16	M20	M24	M30
d_b	Brush diameter	[mm]	12	14	16	20	26	30	37

**RAWL R-KEM II / RAWL R-KEM II-S / RAWL R-KEM II-W
and RAWL RM50 / RAWL RM50-S / RAWL RM50-W**

Intended use
Tools

Annex B4
of European
Technical Assessment
ETA-21/0243



	<p>1. Drill hole to the required diameter and depth using a rotary hammer.</p>
<p>a.</p> 	<p>2. Hole cleaning. Clean the hole with brush and hand pump:</p> <ul style="list-style-type: none"> - starting from the drill hole bottom blow the hole at least 4 times using the hand pump, - using the specified brush, mechanically brush out the hole at least 4 times, - starting from the drill hole bottom, blow at least 4 times with the hand pump.
	<p>3. Insert cartridge into dispenser and attach nozzle. Dispense to waste until even colour is obtained.</p>
	<p>4. Insert the mixing nozzle to the far end of the hole and inject resin, slowly withdrawing the nozzle as the hole is filled to 2/3 of its depth.</p>
	<p>5. Immediately insert the ros, slowly and with slight twisting motion. Remove any excess mortar around the hole before it sets.</p>
	<p>6. Leave the fixing undisturbed until the curing time elapses.</p>
	<p>7. Attach fixture and tighten the nut to the required torque. The installation torque cannot exceed $T_{inst,max}$.</p>
<p>RAWL R-KEM II / RAWL R-KEM II-S / RAWL R-KEM II-W and RAWL RM50 / RAWL RM50-S / RAWL RM50-W</p>	<p>Annex B5</p>
<p>Intended use Installation instruction</p>	<p>of European Technical Assessment ETA-21/0243</p>

Table C1: Characteristic resistance under tension load in uncracked concrete – static and quasi-static loads

Size			M8	M10	M12	M16	M20	M24	M30	
Steel failure										
Steel failure with standard threaded rod grade 5.8										
Characteristic resistance	$N_{Rk,s}$	[kN]	18	29	42	78	122	176	280	
Partial safety factor	$\gamma_{Ms}^{1)}$	[-]	1,50							
Steel failure with standard threaded rod grade 8.8										
Characteristic resistance	$N_{Rk,s}$	[kN]	29	46	67	126	196	282	449	
Partial safety factor	$\gamma_{Ms}^{1)}$	[-]	1,50							
Steel failure with standard threaded rod grade 10.9										
Characteristic resistance	$N_{Rk,s}$	[kN]	37	58	84	157	245	353	561	
Partial safety factor	$\gamma_{Ms}^{1)}$	[-]	1,40							
Steel failure with standard threaded rod grade 12.9										
Characteristic resistance	$N_{Rk,s}$	[kN]	44	70	101	188	294	424	673	
Partial safety factor	$\gamma_{Ms}^{1)}$	[-]	1,40							
Steel failure with standard stainless steel threaded rod A4-70										
Characteristic resistance	$N_{Rk,s}$	[kN]	26	41	59	110	171	247	393	
Partial safety factor	$\gamma_{Ms}^{1)}$	[-]	1,87							
Steel failure with standard stainless steel threaded rod A4-80										
Characteristic resistance	$N_{Rk,s}$	[kN]	29	46	67	126	196	282	449	
Partial safety factor	$\gamma_{Ms}^{1)}$	[-]	1,60							
Steel failure with standard high corrosion threaded rod grade 70										
Characteristic resistance	$N_{Rk,s}$	[kN]	26	41	59	110	171	247	393	
Partial safety factor	$\gamma_{Ms}^{1)}$	[-]	1,87							
Combined pull-out and concrete cone failure (working life 50 and/or 100 years)										
Characteristic bond resistance in uncracked concrete C20/25, working life 50 years										
Temperature range I: 40°C/24°C	$\tau_{Rk,ucr,50}$	[N/mm ²]	9,5	9,5	9,0	8,0	8,0	6,5	5,5	
Temperature range II: 80°C/50°C	$\tau_{Rk,ucr,50}$	[N/mm ²]	8,0	8,0	7,5	7,0	6,5	5,0	4,5	
Sustained load factor for $\tau_{Rk,ucr,50}$ in uncracked concrete	$\psi_{sus,50}^0$	40°C/24°C	0,81							
		80°C/50°C	0,76							
Characteristic bond resistance in uncracked concrete C20/25, working life 100 years										
Temperature range I: 40°C/24°C	$\tau_{Rk,ucr,100}$	[N/mm ²]	9,0	9,0	8,5	7,5	7,5	6,0	5,0	
Temperature range II: 80°C/50°C	$\tau_{Rk,ucr,100}$	[N/mm ²]	7,0	7,0	7,0	6,5	6,0	5,0	4,0	
Increasing factors	ψ_c	C30/37	1,04				1,0			
		C40/50	1,07				1,0			
		C50/60	1,09				1,0			

1) In the absence of national regulations

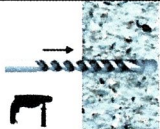
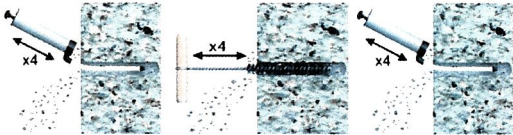
2) h – concrete member thickness

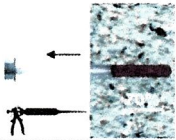
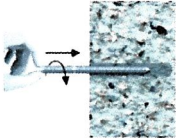
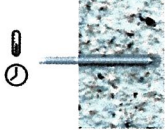
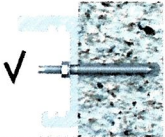
**RAWL R-KEM II / RAWL R-KEM II-S / RAWL R-KEM II-W
and RAWL RM50 / RAWL RM50-S / RAWL RM50-W**

Performances
Characteristic resistance under tension loads in uncracked concrete

Annex C1
of European
Technical Assessment
ETA-21/0243

Table C1: (continuation)

Concrete cone failure					
Factor for uncracked concrete	$k_{ucr,N}$	[-]	11,0		
Edge distance	$c_{cr,N}$	[mm]	$1,5 \cdot h_{ef}$		
Spacing	$s_{cr,N}$	[mm]	$3,0 \cdot h_{ef}$		
Splitting failure					
Edge distance	$c_{cr,sp}$ for h_{min}	[mm]	$2,5 \cdot h_{ef}$	$2,0 \cdot h_{ef}$	$1,5 \cdot h_{ef}$
	$c_{cr,sp}$ for $h_{min} < h^2 < 2 \cdot h_{ef}$ ($c_{cr,sp}$ from linear interpolation)	[mm]			
	$c_{cr,sp}$ for $h^2 \geq 2 \cdot h_{ef}$	[mm]	$c_{cr,Np}$		
Spacing	$s_{cr,sp}$	[mm]	$2,0 \cdot c_{cr,sp}$		
Installation safety factors for combined pull-out, concrete cone and splitting failure					
Installation safety factors for category I1 + I2	γ_{inst}	[-]	1,4	1,2	

- 1) In the absence of national regulations
 2) h – concrete member thickness

**RAWL R-KEM II / RAWL R-KEM II-S / RAWL R-KEM II-W
 and RAWL RM50 / RAWL RM50-S / RAWL RM50-W**

Performances
 Characteristic resistance under tension loads in uncracked concrete (2)

Annex C1
 of European
 Technical Assessment
 ETA-21/0243

Table C2: Characteristic resistance under shear load in uncracked concrete – steel failure without lever arm

Size			M8	M10	M12	M16	M20	M24	M30
Steel failure with standard threaded rod grade 5.8									
Characteristic resistance	$V_{Rk,s}^0$	[kN]	9	14	21	39	61	88	140
Partial safety factor	γ_{Ms}	[-]	1,25						
Ductility factor	k_7	[-]	0,8						
Steel failure with standard threaded rod grade 8.8									
Characteristic resistance	$V_{Rk,s}^0$	[kN]	15	23	34	63	98	141	224
Partial safety factor	γ_{Ms}	[-]	1,25						
Ductility factor	k_7	[-]	0,8						
Steel failure with standard threaded rod grade 10.9									
Characteristic resistance	$V_{Rk,s}^0$	[kN]	18	29	42	78	122	176	280
Partial safety factor	γ_{Ms}	[-]	1,50						
Ductility factor	k_7	[-]	0,8						
Steel failure with standard threaded rod grade 12.9									
Characteristic resistance	$V_{Rk,s}^0$	[kN]	22	35	51	94	147	212	337
Partial safety factor	γ_{Ms}	[-]	1,50						
Ductility factor	k_7	[-]	0,8						
Steel failure with standard stainless steel threaded rod A4-70									
Characteristic resistance	$V_{Rk,s}^0$	[kN]	13	20	29	55	86	124	196
Partial safety factor	γ_{Ms}	[-]	1,56						
Ductility factor	k_7	[-]	0,8						
Steel failure with standard stainless steel threaded rod A4-80									
Characteristic resistance	$V_{Rk,s}^0$	[kN]	15	23	34	63	98	141	224
Partial safety factor	γ_{Ms}	[-]	1,33						
Ductility factor	k_7	[-]	0,8						
Steel failure with high corrosion stainless steel threaded rod grade 70									
Characteristic resistance	$V_{Rk,s}^0$	[kN]	13	20	29	55	86	124	196
Partial safety factor	γ_{Ms}	[-]	1,56						
Ductility factor	k_7	[-]	0,8						

**RAWL R-KEM II / RAWL R-KEM II-S / RAWL R-KEM II-W
and RAWL RM50 / RAWL RM50-S / RAWL RM50-W**

Performances
Characteristic resistance under shear loads in uncracked concrete

Annex C2
of European
Technical Assessment
ETA-21/0243

Table C3: Characteristic values for shear load in uncracked concrete – steel failure with lever arm

Size			M8	M10	M12	M16	M20	M24	M30
Steel failure with standard threaded rod grade 5.8									
Characteristic resistance	$M_{Rk,s}^0$	[Nm]	19	37	65	166	324	561	1124
Partial safety factor	γ_{Ms}	[-]	1,25						
Steel failure with standard threaded rod grade 8.8									
Characteristic resistance	$M_{Rk,s}^0$	[Nm]	30	60	105	266	519	898	1799
Partial safety factor	γ_{Ms}	[-]	1,25						
Steel failure with standard threaded rod grade 10.9									
Characteristic resistance	$M_{Rk,s}^0$	[Nm]	37	75	131	333	649	1123	2249
Partial safety factor	γ_{Ms}	[-]	1,50						
Steel failure with standard threaded rod grade 12.9									
Characteristic resistance	$M_{Rk,s}^0$	[Nm]	45	90	157	400	779	1347	2699
Partial safety factor	γ_{Ms}	[-]	1,50						
Steel failure with standard stainless steel threaded rod A4-70									
Characteristic resistance	$M_{Rk,s}^0$	[Nm]	26	52	92	233	454	786	1574
Partial safety factor	γ_{Ms}	[-]	1,56						
Steel failure with standard stainless steel threaded rod A4-80									
Characteristic resistance	$M_{Rk,s}^0$	[Nm]	30	60	105	266	519	898	1799
Partial safety factor	γ_{Ms}	[-]	1,33						
Steel failure with high corrosion stainless steel threaded rod grade 70									
Characteristic resistance	$M_{Rk,s}^0$	[Nm]	26	52	92	233	454	786	1574
Partial safety factor	γ_{Ms}	[-]	1,56						

**RAWL R-KEM II / RAWL R-KEM II-S / RAWL R-KEM II-W
and RAWL RM50 / RAWL RM50-S / RAWL RM50-W**

Performances
Characteristic resistance under shear loads in uncracked concrete

Annex C3
of European
Technical Assessment
ETA-21/0243

Table C4: Concrete pry out failure and concrete edge failure

Size			M8	M10	M12	M16	M20	M24	M30	
Pry out failure										
Pry-out factor	k_8	[-]	2							
Concrete edge failure										
Outside diameter of anchor	d_{nom}	[mm]	8	10	12	16	20	24	30	
Effective length of anchor shear loading	l_f	[mm]	min (h_{ef} ; $12d_{nom}$)						min (h_{ef} ; 300)	

Table C5: Displacement under tension load

Size			M8	M10	M12	M16	M20	M24	M30
Characteristic displacement in uncracked C20/25 to C50/60 concrete									
Displacement ¹⁾	δ_{N0}	[mm]	0,20	0,25	0,30	0,35	0,40	0,40	0,45
	$\delta_{N\infty}$	[mm]	0,85	0,85	0,85	0,85	0,85	0,85	0,85
¹⁾ These values are suitable for each temperature range and categories specified in Annex B1 Calculation of the displacement: $\delta_{N0} = \delta_{N0\text{-factor}} \cdot N$; $\delta_N = \delta_{N\infty\text{-factor}} \cdot N$; (N – applied tension load)									

Table C6: Displacement under shear load

Size			M8	M10	M12	M16	M20	M24	M30
Characteristic displacement in uncracked C20/25 to C50/60 concrete									
Displacement ¹⁾	δ_{V0}	[mm]	2,0	2,0	2,0	2,0	2,0	2,0	2,0
	$\delta_{V\infty}$	[mm]	3,0	3,0	3,0	3,0	3,0	3,0	3,0
¹⁾ These values are suitable for each temperature range and categories specified in Annex B1 Calculation of the displacement: $\delta_{N0} = \delta_{N0\text{-factor}} \cdot V$; $\delta_N = \delta_{N\infty\text{-factor}} \cdot V$; (V – applied shear load)									

**RAWL R-KEM II / RAWL R-KEM II-S / RAWL R-KEM II-W
and RAWL RM50 / RAWL RM50-S / RAWL RM50-W**

Performances
Displacement under service loads: tension and shear loads

Annex C4
of European
Technical Assessment
ETA-21/0243